

Junbpaw

User Manual

PURE SINE WAVE INVERTER

LGE-1080Ti / LGE-2080Ti / LGE-3080Ti

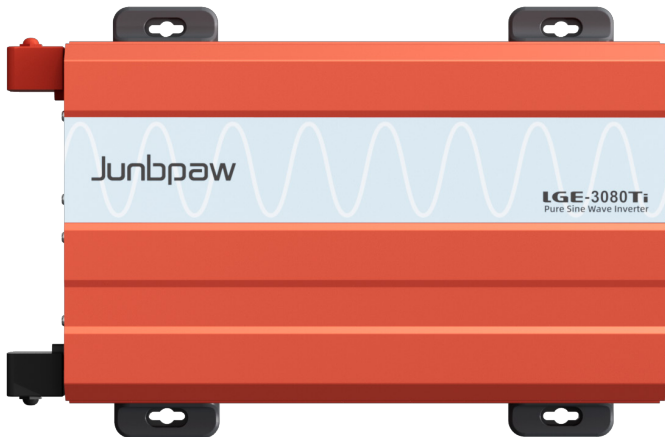

* Please read the instruction manual carefully before

Table of Contents

Product introduction	1
Safety instructions	2
Functional characteristics introduction	4
Product parameters	6
Panel description	9
Dimensions	12
Temperature power curve	13
Socket and wire	14
Remote control	15
Operation guide	17
Common problems and solutions	19

01

Product Introduction

1-1.What is an inverter?

An inverter is an electronic device that converts DC power to AC power. Direct Current (DC) is electricity generated by batteries, while Alternating Current (AC) is the electricity required to operate electrical equipment. An inverter is mainly used when there is no AC power supply.

1-2. Pure sine wave inverter

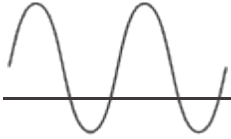

PURE SINE WAVE(PSW)

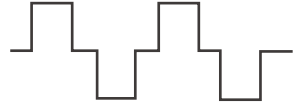

MODIFIED SINE WAVE(MSW)

Pure sine wave inverter technology is based on the principle of AC generator sets on the grid, and the microprocessor (MPU) is designed to control the voltage current waveform. Under the power corresponding, the pure sine wave we designed can be used and responsible for all AC.

The voltage waveform of the pure sine wave on the grid is from the AC power generator. Nikola Tesla invented the first AC generator in 1882, and since then, sine wave alternating current has been generated. The principle is that the conductor winding of the generator set is rotated by the magnetic field S-pole to N-pole rotation. The sine wave voltage and current generated by the changes in this magnetic field are supplied to the load from the normal half wave. Zero gradually increases before gradually decreasing, reversing magnetic field polarity. Negative half waves gradually change in the same way, completing one cycle within a certain period of time. The change in the pure sine wave is like two parabolic changes; the cycle change time is a positive half wave of 10ms plus a negative half wave of 10ms (equal to 20ms). That is 50Hz because the sine wave gradually transforms as parabolas do, so it is enough to be used and responsible for all AC.

02 Safety Instructions

2-1. General Safety Precautions



Warning! Before using the inverter, read the safety instructions.

- Do not expose the inverter to rain, snow, spray, or dust. To reduce the risk of fire hazard, do not cover or obstruct the ventilation openings or install it in a zero-clearance compartment.
- To avoid the risk of fire or electric shocks, ensure that the existing wiring is in good electrical condition and that the wiring is not undersized.
- This equipment contains components that can produce arcs or sparks. To prevent fire or explosion, do not install it in a compartment containing batteries or flammable materials or in a location that requires ignition-protected equipment. This includes any space containing gasoline-powered machinery, fuel tanks, joints, fittings, and other connections between components of the fuel system.
- Depending on the user scenario, the inverter's AC output may require a user-installed breaker or fuse. In an AC output hardwire application, an AC socket will not be provided. The inverter incorporates standard AC shod circuit protection.
- An over current protection at the time of installation shall be provided by others for the AC output circuit.
- Additional breakers suitable for 20 A branch circuit protection shall be provided for the GFCI receptacles.
- The following precautions should be taken when working on the inverter:
 - Step 1 Remove watches, rings, or other metal objects.
 - Step 2 Use tools with insulated handles.
 - Step 3 Wear rubber gloves and boots.

This series of products are off-grid inverters. It is forbidden to connect other AC power supplies with the AC power output of the inverter.

02 Safety Instructions

2-2. Other Safety Notes

- Upon receipt, examine the carton box for any damage. If you have found any signs of damage, please notify the company you purchased the unit from.
- Do not operate near water.
- Do not open or disassemble the inverter, as the warranty may be voided.
- The DC side connections should be firm and tight.
- Grounding: Reliable grounding should be maintained.
- Do not drop a metal tool on the battery. The resulting spark or short-circuit on the battery, or on the other electrical pan may cause an explosion.
- Install the inverter in a well-ventilated area. Do not block the front air vents or the rear air exhausts of the unit.
- Wiring: Adequate input power must be supplied to the inverter for proper use; correct wiring sizes must be ensured.
- Mount the inverter so that the axis of the fan is horizontal.
- Do not operate the inverter close to combustible gas or open fire.
- Do not operate appliances that may feed power back into the inverter.
- Temperature: The inverter should be operated in an ambient temperature range of -30°C to 60°C ; otherwise, the output efficiency may be affected. Airflow to the inverter must not be blocked.

03

Functional Characteristics Introduction

3-1. System

The unit is a highly reliable DC-AC inverter system, designed with advanced power electronic and microprocessor technology offering the following features:

- Pure sine wave output waveform O/P voltage THD<3%.
- Intelligent software for power management.
- Loading and temperature-controlled cooling fan.
- Dry contact terminal.
- Advanced Protection Features
 - Input over/under voltage protection
 - Internal over-temperature protection
 - Input reverse polarity protection (Fuse)
 - Output overload protection
 - Output short circuit protection
- SPWM technology is controlled by MCU micro-processing, pure sine wave output.
- Unique dynamic current loop control technology to ensure reliable operation of the inverter.
- Strong load adaptability, including inductive load, capacitive load, resistive load, and mixed load.

03

Functional Characteristics Introduction

3-2. Protective function

- 1) Low-voltage alarm: The buzzer sounds 2 times with a 1Hz gap.
- 2) Low voltage protection: The buzzer alarm continuously sounds for 3 times, with a 1Hz gap.
- 3) Low-voltage recovery: The low-voltage rise automatically restores the output, and the buzzer sounds 3 times before the alarm is cancelled.
- 4) Overvoltage protection: The buzzer sounds 4 times, with a 1Hz gap.
- 5) Overvoltage recovery: The voltage is reduced automatically to restore the output, and the buzzer sounds 4 times before the alarm is cancelled.
- 6) Thermal protection: $85^{\circ} \pm 5^{\circ}$, when overheat protection is activated, the buzzer sounds 5 times, with a 1Hz gap.
- 7) Overload protection:
 - a.overload 100%~115% 60s Turn off,
 - b.overload 116%~150% 3s Turn off,
 - c.overload 151%~200% 1s Turn off,
 - d.overload>200%,
 - e.200ms Turn off, the buzzer blared.
- 8) Short circuit protection: Output short circuit protection 3s shutdown lock.
- 9) GFCI protection:socket built-in GFCI protector, detected electrical leakage, socket automatically trip, and turn off the output.
- 10) GFCI Working Status
 - a.Green light:GFCI working properly; Cyclic testing every 15 minutes.
 - b.Red light blinking: GFCI Self-Testing.
 - c.Red light On ALERT ! : GFCI reached its service life and needs to bereplaced.
 - d.Led Off (No power) :GFCI tripped, press RESET button;Check the power circuit if can not reset.

3-3. Block Diagram



04 Product parameters

4-1.electrical code LGE-1080Ti standard

MODEL NO.		LGE-1080Ti		
OUTPUT	Rated Power (Typ.)	1080W		
	Maximum Output Power (1 Min)	>1080W~ 1242W (100%~ 115%)		
	Surge Power (Max. 300 ms)	>3000W		
	AC Voltage	100/110/120VAC		
	Frequency	50/60 Hz±0.5%		
	Waveform	Pure sine wave (THD<3%)		
	AC Regulation (Typ.)	±5%		
	Voltage Switching	1.Adjustable 110V/120V, S3=120V, S4=110V; 2.Adjustable 100V/110V, S3=110V, S4=100V		
	Frequency Switching	Adjustable, 50/60Hz, S1=60Hz, S2=50Hz, (Frequency switching supports cold switching only)		
	USB	Output voltage: 5V output current: 2.1A maximum power: 10.5W		
	LED Indicator	Input Voltage level,output load level and faulty status		
INPUT	DC Voltage	12VDC	24 VDC	48 VDC
	Voltage Range	10.5~ 16.5VDC	21.0~33.0VDC	42.0~66 .0VDC
	No Load Current	0.6A	0.3A	0.2A
	Efficiency (max)	91%	93%	93%
	Remote Standby Mode	≤ 0.08W	≤ 0.08W	≤ 0.08W
PROTECTION	Input Under - Voltage Protection	10.0 ± 0.3VDC	20.0± 0.5VDC	41.0 ± 1.0VDC
	Input Under - Voltage Recovery	12.5 ± 0.3VDC	25.0± 0.5VDC	50.0 ± 1.0VDC
	Input Over - Voltage Protection	16.5 ± 1.0VDC	33.0± 1.0VDC	63.0 ± 1.0VDC
	Input Over - Voltage Recovery	15.0 ± 0.5VDC	30.0± 0.5 VDC	58.0 ± 1.0VDC
	Output Overload	1080W ≥ 115%		
		1minute automatic shutdown output , automatic lock, restart to recover		
	Output Short Circuit	Output short circuit protection 3s shutdown lock, restart to recover		
	Over Temperature	85℃ ±5 ℃		
DC Input Reverse Polarity	By internal fuse open			
SAFETY & EMC	Withstand Voltage	Bat I/P-AC O/P:3.0 KVAC AC O/P -FG:1.5 KVAC		
	Isolation Resistance	Bat I/P-AC O/P, Bat I/P - FG, AC O/P-FG:10.0 M ohms / 50.0VDC/ 25 ℃/70% RH		
	EMC Emission	Compliance to FCC classA, E- Mark EACTPTC 02.0.EN55 0 3.2 classA, 72/ 24.5/ CEE,9.5/5.4/ CE		
	EMC Immunity	Compliance to EAC TPTC 020 , EN61000-4-2 ,3 ,4 ,5 ,6 , 8 , 11		
ENVIRONMENT	Working Temp	-30℃ ~ 60℃		
	Working Humidity	20~90% RH		
	Storage Temp, Humidity	-30~70 ℃ / -22~+158F , 10~95% RH non-condensing		
OTHERS	Dimension	312*185*73mm		
	Packing	≈ 2.3 KG		

Note1 - Normal Condition: Vin=12.5V / 25V / 50V Vo=100 / 110 / 120 VAC 80% Full load (PF=1.0)

Note2 - Warning: This is a class A product. In a domestic environment this product may cause radio interference in which case the user may be required to take adequate measures.

04

Product parameters

4-2.electrical code
LGE-2080Ti standard

MODEL NO.		LGE-2080Ti		
OUTPUT	Rated Power (Typ.)	2080W		
	Maximum Output Power (1 Min)	>2080W~ 2392W (100%~ 115%)		
	Surge Power (Max. 300 ms)	>6000W		
	AC Voltage	100/110/120VAC		
	Frequency	50/60 Hz±0.5%		
	Waveform	Pure sine wave (THD<3%)		
	AC Regulation (Typ.)	±5%		
	Voltage Switching	1.Adjustable 110V/120V S3=120V, S4=110V; 2.Adjustable 100V/120V, S3=110V, S4=100V		
	Frequency Switching	Adjustable 50/60Hz, S1=60Hz, S2=50Hz, (Frequency switching supports cold switching only)		
	USB	Output voltage: 5V output current: 2.1A maximum power: 10.5W		
	LED Indicator	Input Voltage level,output load level and faulty status		
INPUT	DC Voltage	12VDC	24 VDC	48 VDC
	Voltage Range	10.5~ 16.5VDC	21.0~33.0VDC	42.0~66.0VDC
	No Load Current	0.7A	0.4A	0.25A
	Efficiency (max)	91%	93%	94%
	Remote Standby Mode	≤ 0.08W	≤ 0.08W	≤ 0.08W
PROTECTION	Input Under - Voltage Protection	10.0 ± 0.3VDC	20.0± 0.5VDC	41.0 ± 1.0VDC
	Input Under - Voltage Recovery	12.5 ± 0.3VDC	25.0± 0.5VDC	50.0 ± 1.0VDC
	Input Over - Voltage Protection	16.5 ± 1.0VDC	33.0± 1.0VDC	63.0 ± 1.0VDC
	Input Over - Voltage Recovery	15.0 ± 0.5VDC	30.0± 0.5 VDC	58.0 ± 1.0VDC
	Output Overload	2080W ≥ 115%		
		1minute automatic shutdown output , automatic lock, restart to recover		
	Output Short Circuit	Output short circuit protection 3s shutdown lock, restart to recover		
	Over Temperature	85 C±5 C		
DC Input Reverse Polarity	By internal fuse open			
SAFETY & EMC	Withstand Voltage	Bat I/P-AC O/P:3.0 KVAC AC O/P -FG:1.5 KVAC		
	Isolation Resistance	Bat I/P-AC O/P, Bat I/P - FG, AC O/P-FG:10 0 M ohms / 50 0VDC/ 25 C/70% RH		
	EMC Emission	Compliance to FCC classA, E-Mark EACTPTC 02 0.EN55 0 3 2 classA, 72/ 24 5/ CEE,9 5/5 4/ CE		
	EMC Immunity	Compliance to EAC TPTC 020 , EN61000-4-2 ,3 ,4 ,5 ,6 ,8 , 11		
ENVIRONMENT	Working Temp	-30 C ~ 60 C		
	Working Humidity	20~90% RH		
	Storage Temp, Humidity	-30~70 C / -22~+158F , 10~95% RH non-condensing		
OTHERS	Dimension	364.5*243*70mm		
	Packing	≈ 3.8 KG		

Note1 - Normal Condition: Vin=12.5V / 25V / 50V Vo=100 / 110 / 120 VAC 80% Full load (PF=1.0)

Note2 - Warning: This is a class A product. In a domestic environment this product may cause radio interference in which case the user may be required to take adequate measures.

MODEL NO.		LGE-3080Ti		
OUTPUT	Rated Power (Typ.)	3080W		
	Maximum Output Power (1 Min)	>3080W~ 3542W (100%~115%)		
	Surge Power (Max. 300 ms)	>9000W		
	AC Voltage	100/110/120VAC		
	Frequency	50/60 Hz±0.5%		
	Waveform	Pure sine wave (THD<3%)		
	AC Regulation (Typ.)	±5%		
	Voltage Switching	1.Adjustable 110V/120V,S3=120V, S4=110V; 2.Adjustable 100V/110V,S3=110V, S4=100V		
	Frequency Switching	Adjustable 50/60Hz , S1=60Hz, S2=50Hz, (Frequency switching supports cold switching only)		
	USB	Output voltage: 5V output current: 2.1A maximum power: 10.5W		
	LED Indicator	Input Voltage level,output load level and faulty status		
INPUT	DC Voltage	12VDC	24 VDC	48 VDC
	Voltage Range	10.5~ 16.5VDC	21.0~33.0VDC	42.0~66 .0VDC
	No Load Current	0.8A	0.5A	0.25A
	Efficiency (max)	91%	92%	93%
	Remote Standby Mode	≤ 0.08W	≤ 0.08W	≤ 0.08W
PROTECTION	Input Under - Voltage Protection	10.0 ± 0.3VDC	20.0± 0.5VDC	41.0 ± 1.0VDC
	Input Under - Voltage Recovery	12.5 ± 0.3VDC	25.0± 0.5VDC	50.0 ± 1.0VDC
	Input Over - Voltage Protection	16.5 ± 1.0VDC	33.0± 1.0VDC	63.0 ± 1.0VDC
	Input Over - Voltage Recovery	15.0 ± 0.5VDC	30.0± 0.5 VDC	58.0 ± 1.0VDC
	Output Overload	3080W ≥ 115%		
		1minute automatic shutdown output , automatic lock, restart to recover		
	Output Short Circuit	Output short circuit protection 3s shutdown lock, restart to recover		
	Over Temperature	85 C ±5 C		
DC Input Reverse Polarity	By internal fuse open			
SAFETY & EMC	Withstand Voltage	Bat I/P-AC O/P:3.0 KVAC AC O/P -FG:1.5 KVAC		
	Isolation Resistance	Bat I/P-AC O/P, Bat I/P - FG, AC O/P- FG:10.0 M ohms / 50 0VDC/ 25 C/70% RH		
	EMC Emission	Compliance to FCC classA , E- Mark EACTPTC 02.0,EN55 0 3.2 classA, 72/ 24.5/ CEE,9.5/5.4/ CE		
	EMC Immunity	Compliance to EAC TPTC 020 , EN61000-4-2 ,3 ,4 ,5 ,6 ,8 , 11		
ENVIRONMENT	Working Temp	-30 C ~ 60 C		
	Working Humidity	20~90% RH		
	Storage Temp, Humidity	-30~70 C / -22~+158F , 10~95% RH non-condensing		
OTHERS	Dimension	404.5*265*70mm		
	Packing	≈ 5.8 KG		

Note1 - Normal Condition: Vin=12.5V / 25V / 50V Vo=100 / 110 / 120 VAC 80% Full load (PF=1.0)

Note2 - Warning: This is a class A product. In a domestic environment this product may cause radio interference in which case the user may be required to take adequate measures .

05 Panel description



Figure 1

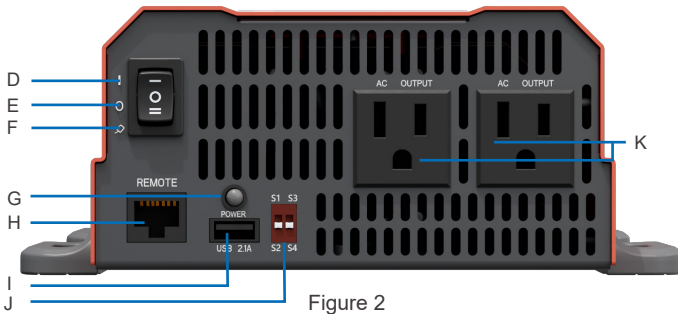

Figure 2

POWER: 1080W

Model	LGE-1080Ti	
A	Fan	1. temperature detection, forced air cooling; 2. Start the fan with load power;
B	Negative Battery Terminal	Connect the negative terminal of the battery
C	Positive Battery Terminal	Connect the positive terminal of the battery
D	Open	Inverter switch is on
E	Close	Inverter switch is off
F	Remote control	Remote control switch is on
G	Indicator light	Green: Inverter normal output, low voltage warning
		Red: short circuit, over temperature, over voltage, over load, under voltage protection
H	Remote port	RJ45 network interface
I	USB Charging	output voltage:5V ; output current:2.1A ; maximum power:10.5W
J	S1,S2	Frequency Switching: Adjustable 50/60Hz, S1=60Hz, S2=50Hz
	S3,S4	Voltage Switching: Adjustable 110V/120V , S3=120V, S4=110V
K	Terminal output (AC)	AC output socket

05 Panel description

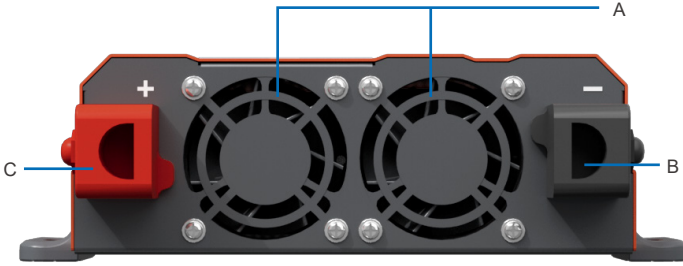

Figure 3

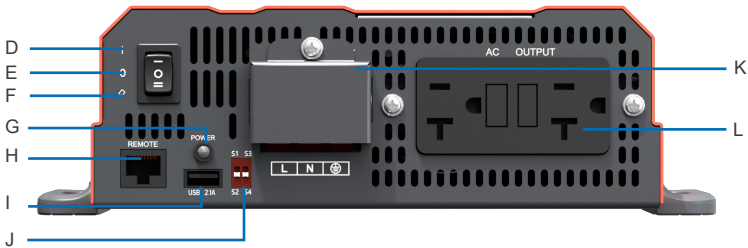

Figure 4

POWER: 2080W

Model	LGE-2080Ti	
A	Fan	1. temperature detection, forced air cooling; 2. Start the fan with load power;
B	Negative Battery Terminal	Connect the negative terminal of the battery
C	Positive Battery Terminal	Connect the positive terminal of the battery
D	Open	Inverter switch is on
E	Close	Inverter switch is off
F	Remote control	Remote control switch is on
G	Indicator light	Green: Inverter normal output, low voltage warning Red: short circuit, over temperature, over voltage, over load, under voltage protection
H	Remote port	RJ45 network interface
I	USB Charging	output voltage:5V ; output current:2.1A ; maximum power:10.5W
J	S1,S2	Frequency Switching: Adjustable 50/60Hz, S1=60Hz, S2=50Hz
	S3,S4	Voltage Switching: Adjustable 110V/120V , S3=120V, S4=110V
K	Terminal output (AC)	AC output terminal (GFCI)
L	Terminal output (AC)	AC output socket (GFCI)

05 Panel description

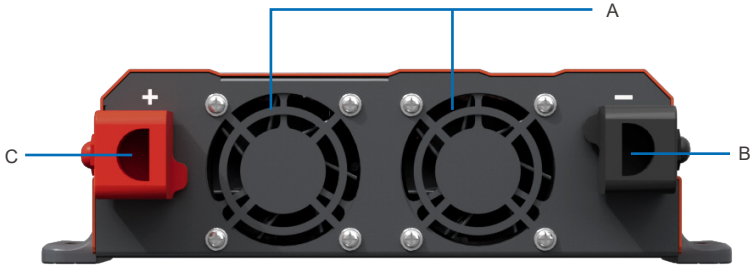

Figure 5

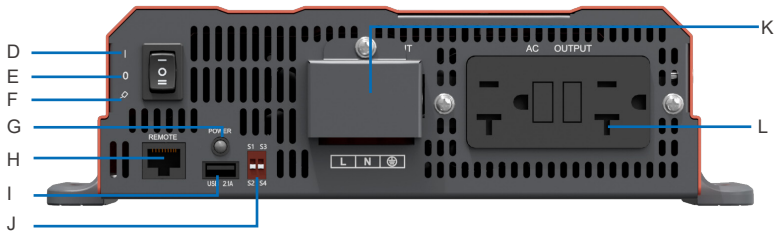

Figure 6

POWER: 3080W

Model	LGE-3080Ti	
A	Fan	1. temperature detection, forced air cooling; 2. Start the fan with load power;
B	Negative Battery Terminal	Connect the negative terminal of the battery
C	Positive Battery Terminal	Connect the positive terminal of the battery
D	Open	Inverter switch is on
E	Close	Inverter switch is off
F	Remote control	Remote control switch is on
G	Indicator light	Green: Inverter normal output, low voltage warning Red: short circuit, over temperature, over voltage, over load, under voltage protection
H	Remote port	RJ45 network interface
I	USB Charging	output voltage:5V ; output current:2.1A ; maximum power:10.5W
J	S1,S2	Frequency Switching: Adjustable 50/60Hz, S1=60Hz, S2=50Hz
	S3,S4	Voltage Switching: Adjustable 110V/120V , S3=120V, S4=110V
K	Terminal output (AC)	AC output terminal (GFCI)
L	Terminal output (AC)	AC output socket (GFCI)

06 Dimensions

LGE-1080Ti

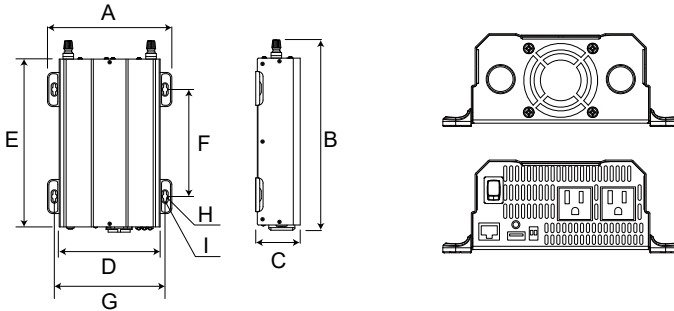

LGE-2080Ti

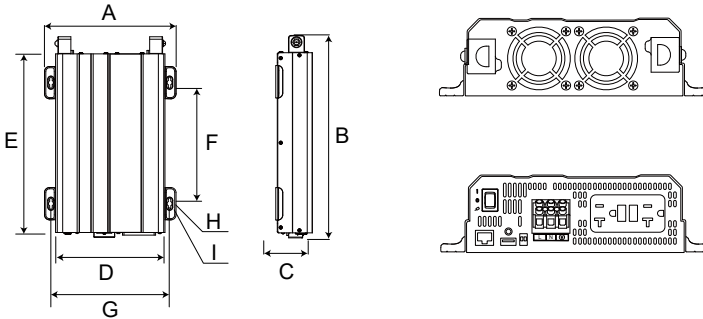

LGE-3080Ti

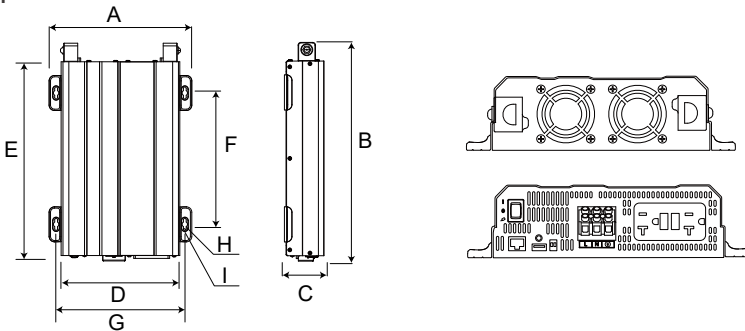

Model	A (mm)	B (mm)	C (mm)	D (mm)	E (mm)	F (mm)	G (mm)	H (mm)	I (mm)
LGE-1080Ti	185	312	70	140	270	154	158.5	Ø10	Ø5.2
LGE-2080Ti	243	364	70	198	320	204	211	Ø10	Ø5.2
LGE-3080Ti	265	404.5	70	220	360	244	239	Ø10	Ø5.2

07

Temperature Power Curve

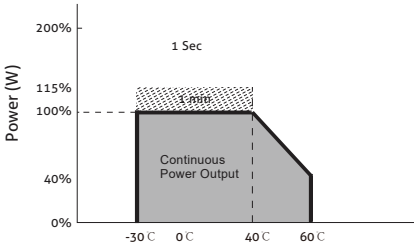

Ambient Temperature(C)
LGE-1080Ti
curve 1

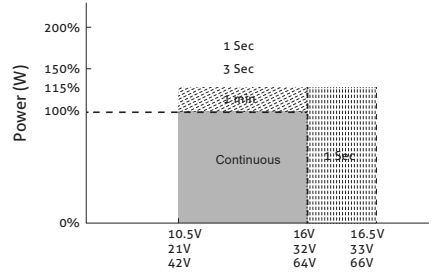

Battery input voltage (V)
LGE-1080Ti
curve 2

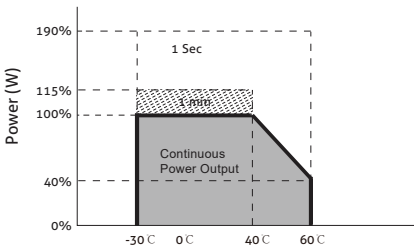

Ambient Temperature(C)
LGE-2080Ti
curve 1

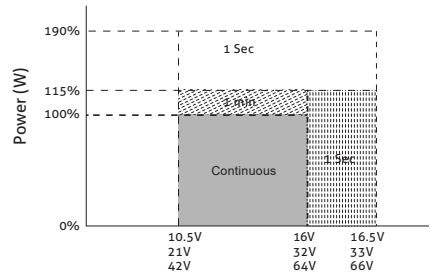

Battery input voltage (V)
LGE-2080Ti
curve 2

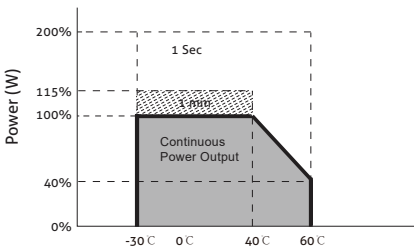



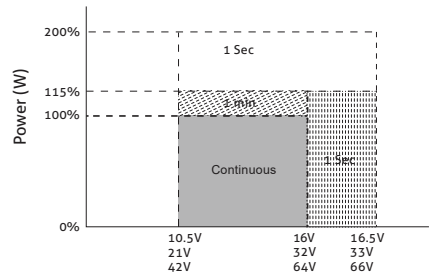





Ambient Temperature(C)
LGE-3080Ti
curve 1



Battery input voltage (V)
LGE-3080Ti
curve 2

08 Socket and Wire

Socket type			 (Terminal inside case only, no AC socket)					 (Terminal inside case only, no AC socket)
	Standard	Optional	Optional	Standard	Optional	Optional	Optional	Optional
Country	USA	GFCI (60Hz)	—	—	AUSTRALIA	U.K	EUROPE	—

Inverter type	Input Voltage	DC Battery Cable	Fuse	Battery Capacity
LGE-1080Ti	12V	5AWG	30A*6	≥180Ah
	24V	10AWG	20A*4	≥80Ah
	48V	12AWG	10A*4	≥40Ah
LGE-2080Ti	12V	3AWG	40A*8	≥320Ah
	24V	5AWG	40A*4	≥160Ah
	48V	10AWG	20A*4	≥80Ah
LGE-3080Ti	12V	2AWG	40A*12	≥480Ah
	24V	5AWG	40A*6	≥240Ah
	48V	5AWG	20A*6	≥120Ah

Wire rod

3 inch



Positive electrode connecting wire



Negative electrode connecting wire

09 Remote control

Control methods (3 types)

NO.1 way

RJ45 control switch, wire length
5 meters (standard configuration)



NO.2 way

Remote control (optional)



NO.3 way

LCD remote control display and RJ45 cable, cable length 5 meters (optional)



External display screen



Connecting Line

09

Remote control

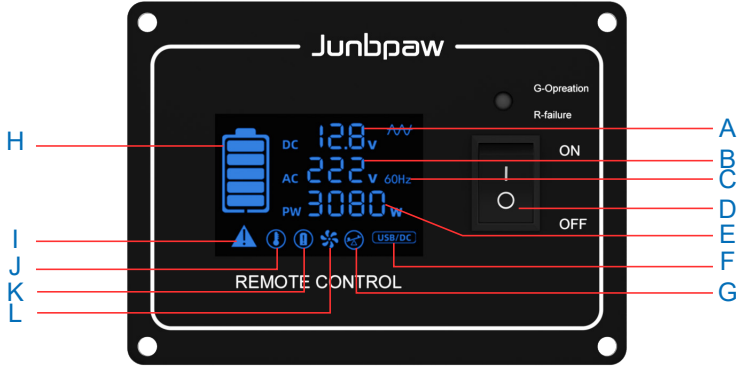

Model	External display screen	
A	Battery DC voltage	Accuracy±1%
B	Output AC Voltage	Accuracy ±1%
C	Frequency	50/60Hz
D	Switch Control	
E	Output Power	Accuracy ±5%
F	USB	output 5V 2.1A
G	Overload/Short Circuit Reminder	
H	Power Ratio	20%-100% displayed , 50/60 Hz
I	Failure Warning	
J	Overheating Protection	
K	Voltage Failure	
L	Fan Start	

10 Operation guide

10-1. Connecting the input power

Before making the DC input side connections, the main switch must be “OFF”. First, connect one end of the cable to the positive and negative terminals of the inverter and then connect the other end of the cable to 12V / 24V / 48V battery in the positive and negative terminals of the pool or other DC power supply, [+] is the positive electrode, and [-] is the negative electrode.

The reverse polarity connection can blow the internal fuse and may damage the inverter permanently.

Make sure that all the DC connections are tight (torque to 2.2 2.5 ft-lbs, 3 3.5 Nm). Loose connections could result in overheating and can be a potential hazard.



10-2. Connecting the loads

Calculate the total power consumption of the output load. Make sure that the total power consumption does not exceed the rated power.

If the total power consumption is over the rated power of the inverter, remove the non-critical loads until the total power consumption is below the rated power.

10 Operation guide

10-3. AC output port

The inverter switch must be in the off state before connecting the cables., as shown in the following figure.

- Ⓐ The live wire
- Ⓑ The neutral line
- Ⓒ The earth wire

Wiring procedure

- Step 1: Connect the earth wire
- Step 2: Connect the neutral wire
- Step 3: Connect the live wire

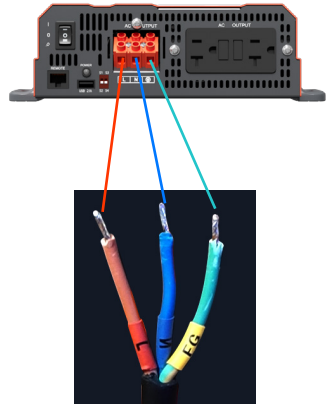

10-4. Turn ON Inverter

Set the power switch to the “ON” position . The inverter will carry out self-diagnosis and, the LED’s will also appear various colors. Set the power switch to the “OFF” position. The inverter stops and all the lights that are on will go off.

11

Common Problems And Solutions

- The inverter may be affected by some strong electromagnetic waves, such as nearby motors, power inverters, strong magnetic fields, etc.
- The inverter indicator is not lit
 1. The battery and inverter are not connected.
 2. The pole of the battery is reversed and the fuse is blown. Replace the fuse.
- Low output voltage
 1. Overload, the load current exceeds the nominal current, and some of the load is turned off.
 2. The input voltage is too low. Make sure the input voltage is within the normal voltage range.
- Low voltage alarm
 1. The battery is out of power and needs to be charged.
 2. The battery voltage is too low or the contact is poor, recharge, check the battery terminals, and clean the terminals with a dry cloth.
- Inverter has no output
 1. The battery voltage is too low, recharge or replace the battery.
 2. The load current is too high, and some of the load is turned off.
Restart the inverter.
 3. Inverter over temperature protection. Allow the inverter to cool for a while, and place it in a well-ventilated area.
 4. The inverter failed to start and restarted.
 5. The terminal is reversed, the fuse is blown, and the fuse needs to be replaced.
- Warm reminder:

*Based on better product performance optimization, the company has the right to optimize and upgrade the product without further notice to the user.



Shenzhen Green Light New Energy Co., Ltd

Tel: +86 755 8171 9267

Website: <https://www.jnbpower.com/>

Technical Support: support@jnbpower.com

Project: info@jnbpower.com

Address: Floor 5, Building A5, Xinjianxing Science and Technology Industrial Park,
Guangming District, Shenzhen, China

Copyright©2006 Shenzhen Green Light New Energy Co.,Ltd. All Rights Reserved.